

electriQ

USER MANUAL

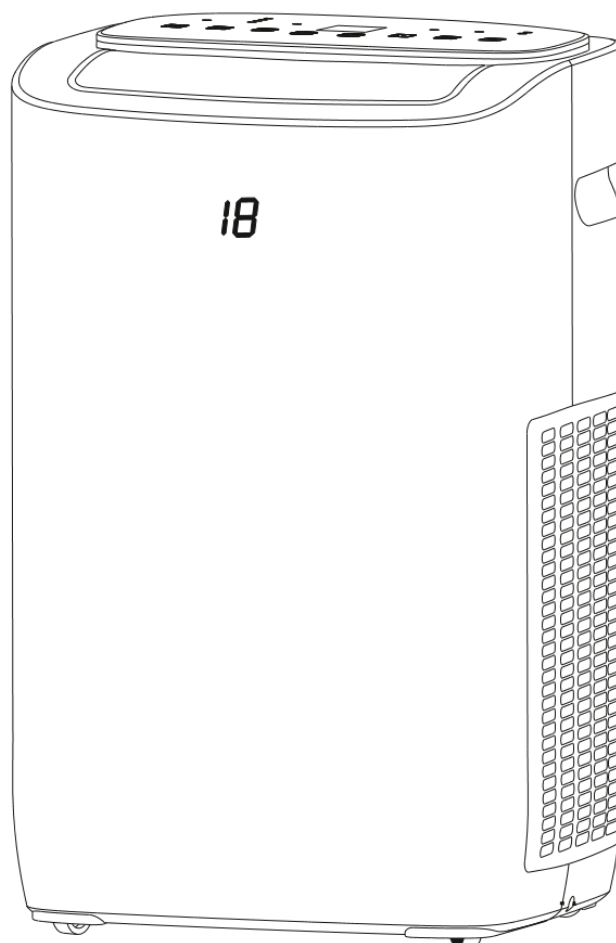

electriQ 10,000 BTU PORTABLE AIR CONDITIONER WITH HEAT PUMP AND WIFI

ECOSILENT10HPW

Thank you for choosing electriQ

Please read this user manual before using this innovative Air Conditioner and keep it safe for future reference.

Visit our page www.electriQ.co.uk for our entire range of Intelligent Electricals

SETTLING IN OK?

We hope this has been helpful to you.

We would love to see how you're getting on with your new purchase, so please share any snaps you have on the platform of your choice below.

Our community awaits your uploads - Snap, tag and hashtag away!



@electriQUK

#electriQUK

WE'RE HERE TO HELP

Should you have any problems or questions with your purchase, please contact a member of our customer service team.

☎ 0330 390 3061

✉ support@electriQ.co.uk

Mon-Fri | 9am to 5pm

Unit J6, Lowfields Business Park,
Lowfields Way, Elland
West Yorkshire, HX5 9DA

CONTENTS

SAFETY	3
FEATURES AND PARTS LIST	5
INSTALLATION	6
OPERATION	9
REMOTE CONTROL	10
EMPTYING THE INTERNAL WATER TANK	11
WIFI APP CONTROL	12
SETTING UP THE APP	12
CONNECTING THE AIR CONDITIONER	15
CONTROLLING YOUR DEVICE	17
SMART SCENES	20
CLEANING AND MAINTENANCE	23
TROUBLESHOOTING	24
ERROR CODES	24
SUPPORT	25
TECHNICAL SPECIFICATION	26

SAFETY INSTRUCTIONS



Important!

- Carefully read the instructions before operating the unit
- This appliance is for indoor use only.
- Rating: This unit must be only connected to a 220-240 V / 50 Hz earthed outlet.
- Installation must be in accordance with regulations of the country where the unit is used.
- If you are in any doubt about the suitability of your electrical supply have it checked and, if necessary, modified by a qualified electrician.
- This air conditioner has been tested and is safe to use. However, as with any electrical appliance - use it with care.
- Disconnect the power from the appliance before dismantling, assembling or cleaning.
- Avoid touching any moving parts of the appliance.
- Never insert fingers, pencils or any other objects through the guard
- This appliance is not intended for use by persons (including children) with reduced physical, sensory or mental capabilities. It is also not intended for use by those with a lack of experience and knowledge, unless they have been given supervision or instruction concerning the use of the appliance by a person responsible for their safety.
- Do not leave children unsupervised with this appliance.
- Do not clean the unit by spraying it or immersing it in water.
- Never connect the unit to an electrical outlet using an extension cord. If an outlet is not available, one should be installed by a qualified electrician.
- Never operate this appliance if the cord or plug is damaged. Ensure the power cord is not stretched or exposed to sharp objects/edges.
- A damaged supply cord should be replaced by the manufacturer or a qualified electrician in order to avoid a hazard.
- Any service other than regular cleaning or filter replacement should be performed by an authorised service representative. Failure to comply could result in a voided warranty.
- Do not use the appliance for any purpose other than its intended use.
- **The air conditioner unit must always be stored and transported upright, otherwise irreparable damage may be caused to the compressor; if in doubt we suggest waiting at least 24 hours before starting the unit.**
- Avoid restarting the air conditioning unit unless 3 minutes have passed since being turned off. This prevents damage to the compressor.
- Never use the mains plug as a switch to start and turn off the air conditioning unit. Use the provided ON/OFF button located on the control panel.
- Always place the unit on a dry and stable surface.
- The appliance should not be installed in laundry or wet rooms.
- The appliance must be placed in a room without sources of ignition (for example: open flames, an operating gas appliance or an operating electric heater).

- R290 refrigerant gas complies with European environmental directives.
- R290 has a low GWP (Global Warming Potential) of 3.
- The air conditioner contains about 200g of R290 refrigerant gas.
- Do not use or store in an unventilated space with an area smaller than 9.6 m² per unit.
- The room must be such as to prevent stagnation of possible leaks of refrigerant gas as there could be a danger of fire or explosion should the refrigerant come into contact with electric heaters, stoves or other sources of ignition.
- Refrigerant gas may be odourless.
- Do not use the product and contact the retailer for advice, if damage has occurred to the unit which may have compromised the refrigerant system.
- Any repairs or maintenance must only be carried out on the unit by a suitably qualified engineer. Before opening and servicing the unit the authorised engineer must be in possession of a copy of the manufacturer's service manual and must follow the safety information contained within it to ensure all hazards are minimized.
- The refrigerant system should not be perforated or punctured.

Energy Saving and Unit Safety Protection Tips

- Do not cover or restrict the airflow from the outlet or inlet grills.
- For maximum performance the minimum distance from a wall or objects should be 50cm.
- Keep the filters clean. Under normal conditions, filters should only need cleaning once every three weeks (approximately). Since the filters remove airborne particles, more frequent cleaning may be necessary, depending on the air quality.
- For the initial start-up set the fan speed to maximum and the thermostat to 5 degrees lower than the current temperature. After, set the fan switch to low and set the thermostat to your desired setting.
- To protect the unit, we recommend not using the cooling function when the ambient temperature is higher than 35°C.

FEATURES AND PARTS LIST

- 4 in 1 Cooling, Heating, Fan and Dehumidifier.
- 5 speed DC fan: balancing quiet operation with performance.
- SmartCool Logic for Improved Energy Efficiency.
- HEPA Filter for Air Purification
- 24 Hours Start / Stop Timer
- Digital Thermostat.
- Auto-Restart to retain the settings in the event of power failure.
- WIFI control from app
- Castors and Handles for Enhanced Portability

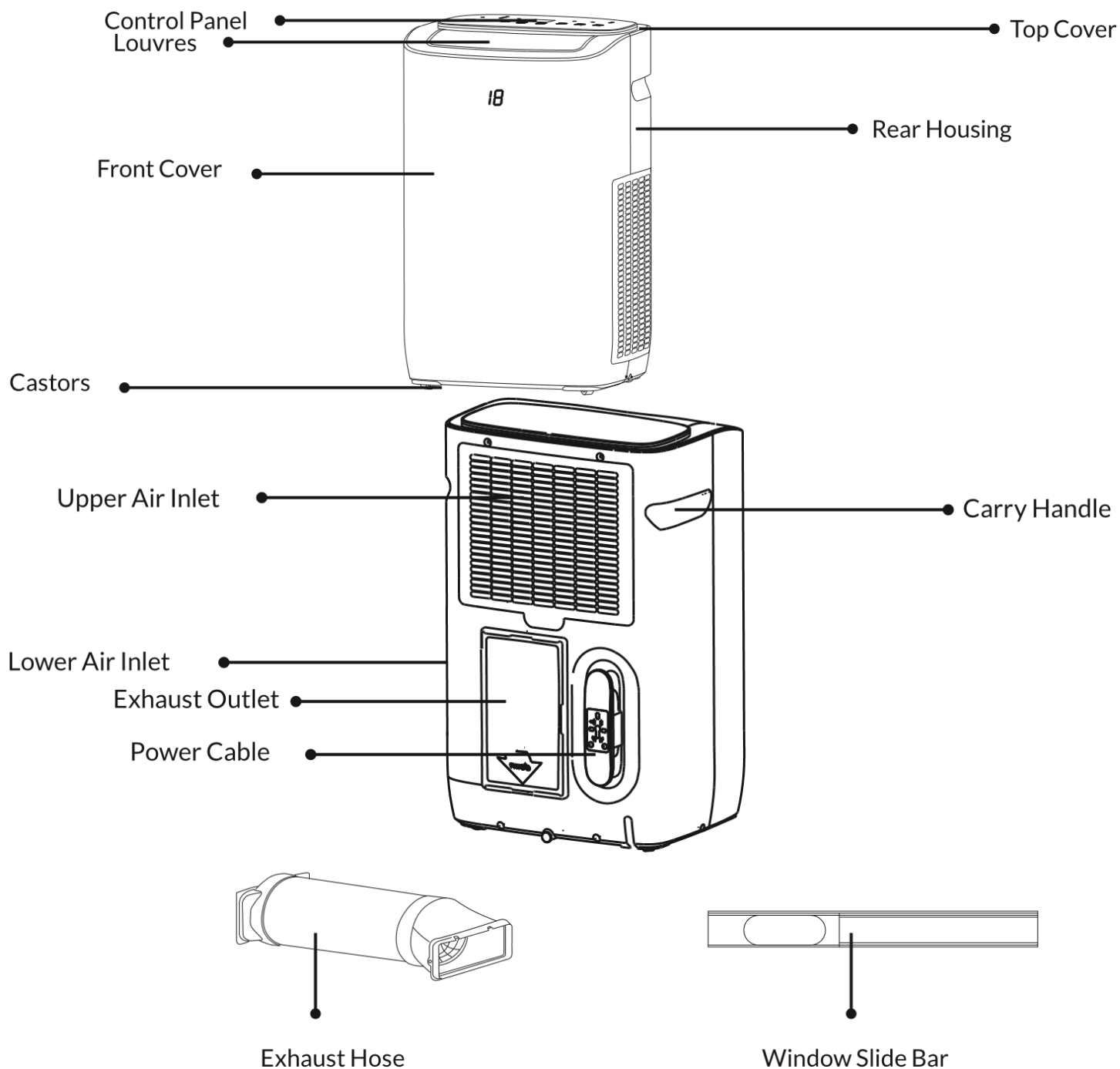

INSTALLATION

WARNING: Before using this unit, please keep it upright for at least 3-4 hours.

This unit can easily be moved from one room to another.

While moving the unit please note that it must always be kept upright and then placed on an even surface.

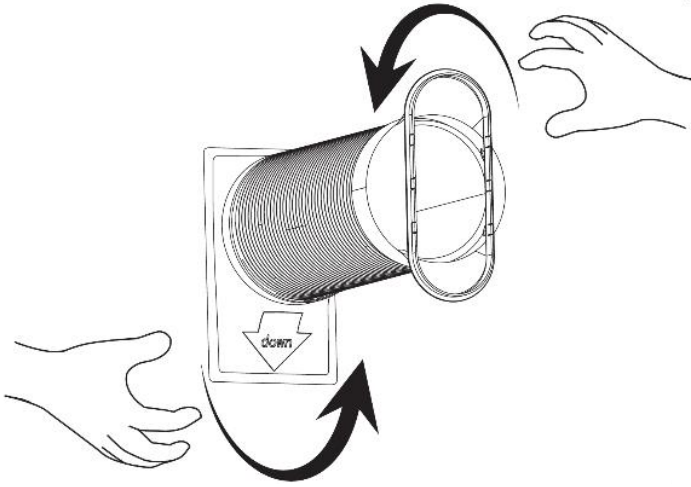

1. Attach the fishtail connector to the end of the hose, by extending the end of the hose and twisting until firmly attached to the connector (At least 3 full rotations).
2. Attach the Hose to the Outlet adaptor, in the same way by extending the end of the hose and twisting until firmly attached (At least 3 full rotations).

3. Slide the Outlet adaptor into position on the rear of the unit. The two slips on the unit will hold it in place. (To remove the adaptor press the two clips down to release it from the unit)

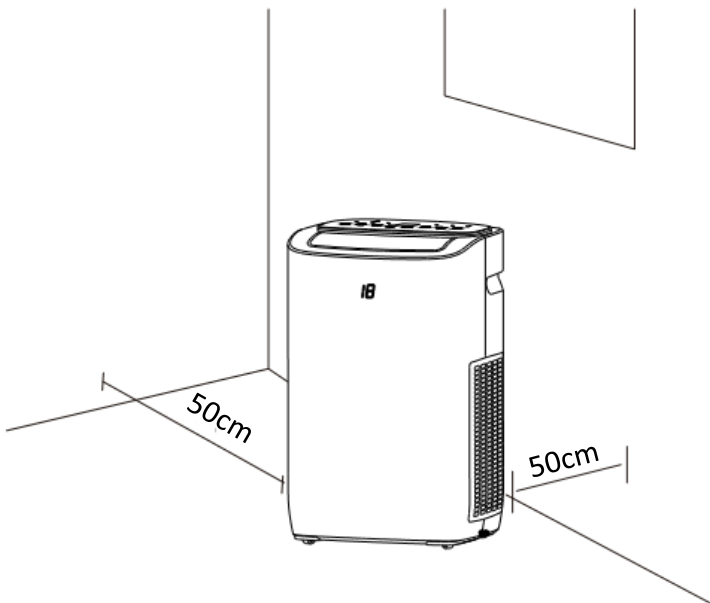
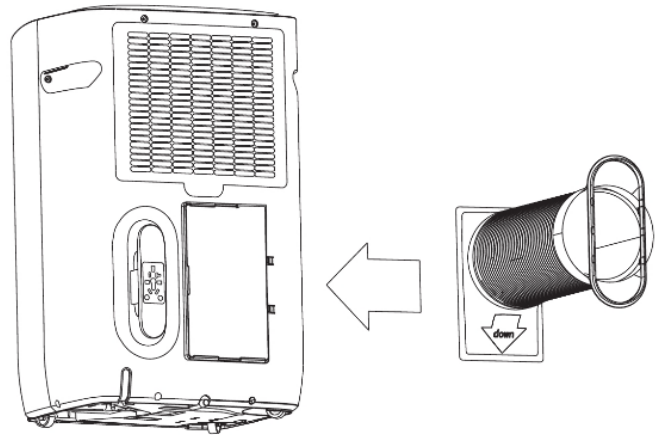

4. Make sure the unit is upright and there are no obstructions to the air inlets and outlet grills, with at least 50cm of space to the sides and rear of the unit.

INSTALLATION OF WINDOW KIT

The window kit (slide bar and fishtail) can be used with sliding windows and doors. For other types of window, the fishtail should be used on its own.

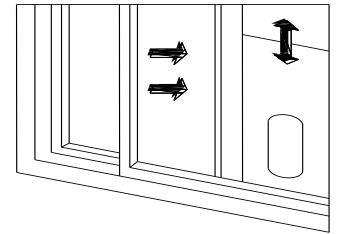
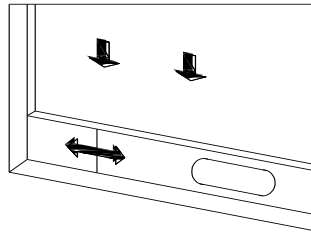

2. Slide the rear section of the slide bar onto the front section lining up the plate so it runs within the groove. Extend the bar to the required length, and use the supplied wing nut to secure

3. Push the screw thread of the plate through the hole in the rear of the front slide bar section.

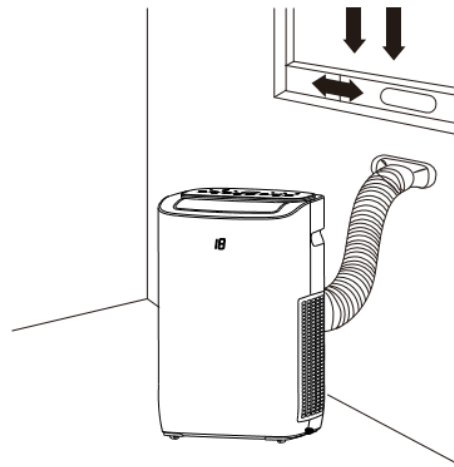
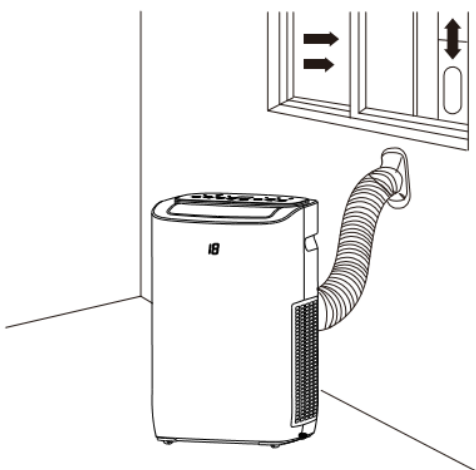
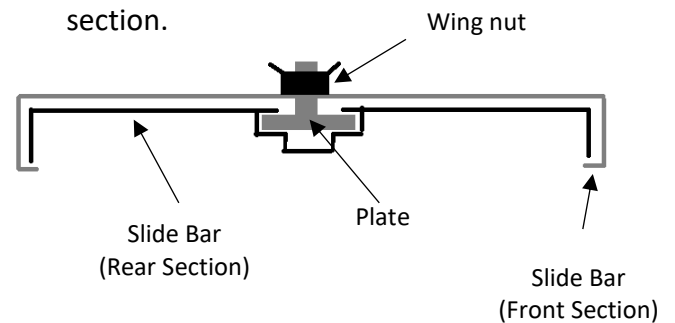

4. Partially open the window and place the extended slide bar in position before closing the window onto it.
5. Fix the fishtail adaptor into the opening on the slide bar.

NOTES:

- The window kit is only designed to be installed with sliding or sash windows or doors. The window kit is not designed to be used with any other style of windows.
- The fish tail adaptor can be used without the slide bar with most windows / doors.
- When using the air conditioner ensure that the opening around the fishtail adaptor is as small as possible to ensure the efficiency of the unit is not reduced.
- The best form of installation is through a wall duct. By properly venting you expel hot air from your room while efficiently cooling it.
- Your air conditioner should be used without the vent pipe in dry mode. When using dry mode ensure that an external water tank is used, monitored and regularly emptied before overflowing. Permanent plumbing can be also installed or an external uplift water pump can be set up to allow for uninterrupted use.

INSTALLING THE HEPA FILTER (OPTIONAL)

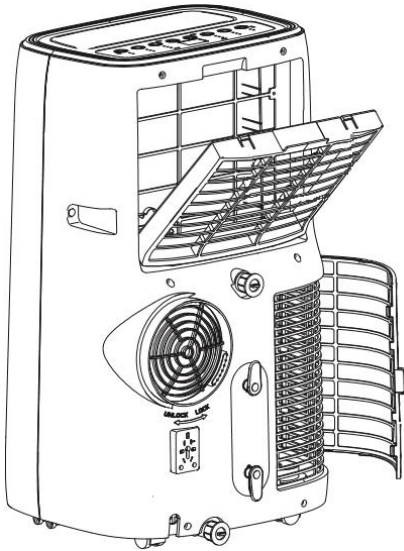

The air conditioner can accommodate a HEPA filter which will purify the air expelled back into the room in any operating mode. These can be purchased from the stockist using the code: **FIL-ECOSILENTHEPA**.

The HEPA filter should be unwrapped and installed in the upper air inlet. To install, remove the upper filter frame from the air conditioner by pressing the two clips on the top of the filter frame. Place the HEPA filter within the filter frame before refitting onto the unit.

In order to maintain performance, the filter should be regularly vacuumed. The filter should be replaced every six months, depending on usage and air quality.

NOTES:

- The window kit is only designed to be installed with sliding or sash windows or doors. The window kit is not designed or to be used with any other style of windows.
- The fish tail adaptor can be used without the slide bar with most windows / doors.
- When using the air conditioner ensure that the opening left around the fishtail is as small as possible to ensure the unit performs efficiently.
- The best form of installation is through a wall duct. By properly venting you expel hot air from your room while efficiently cooling it.
- Your air conditioner should be used without the vent pipe in dry mode. When using dry mode ensure that an external water tank is used, monitored and regularly emptied before overflowing. Permanent plumbing can be also installed for dry mode or an external uplift water pump can be set up for unattended use.

IMPORTANT SAFEGUARDS

The length of the soft hose extends from approximately 35 cm to 180 cm. If hose is extended above this length, the unit may malfunction which can invalidate the warranty. The outlet vent must be well ventilated and not obstructed as this will cause the unit to overheat. Keep the hose as straight and short as possible and avoid bending the air hose by more than 30 degrees in order not to reduce the performance of the unit.

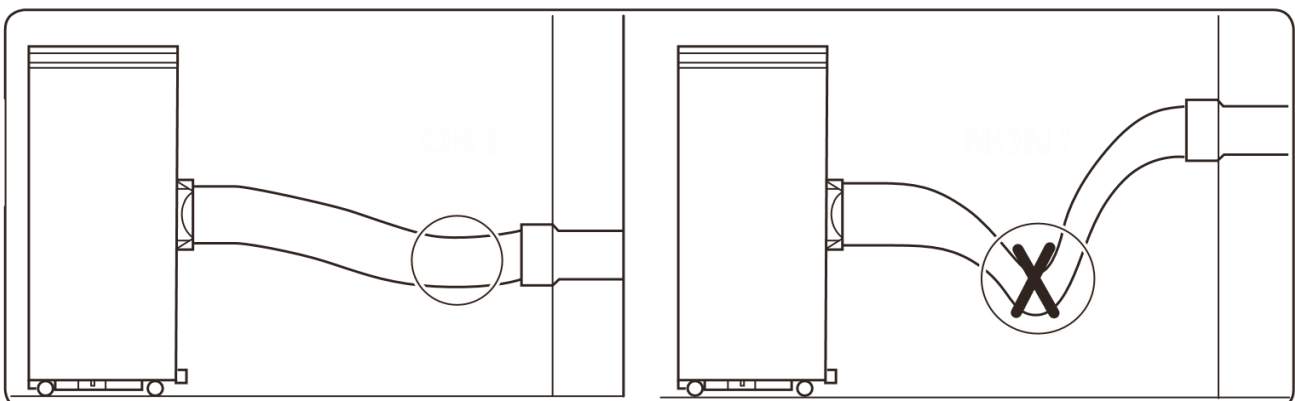

OPERATION

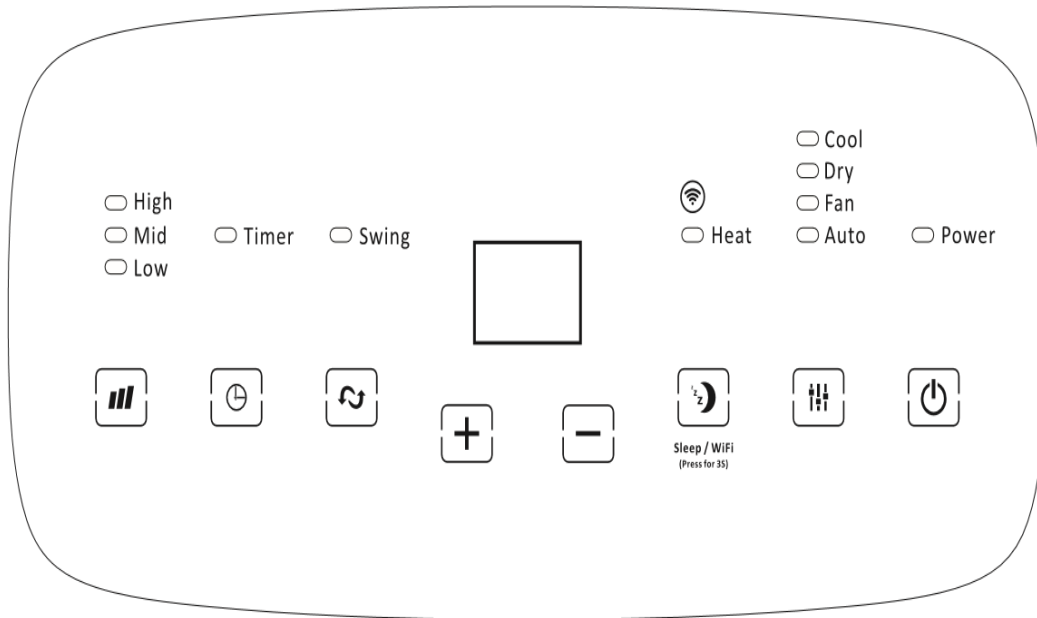

	Press the POWER button to turn the unit ON or OFF.
	<p>Press the MODE button to cycle between the 5 modes, the indicator for the selected mode will be illuminated.</p> <p>COOL: The room is cooled with the cold air expelled through the front air outlet while hot air is expelled through the vent pipe. The desired room temperature can be set between 17 and 30 degrees using the + and – buttons, and the fan speed can be changed using the SPEED button.</p> <p>HEAT: The room is heated with the warm air expelled through the front air outlet while cold air is expelled through the vent pipe. The desired room temperature can be set between 17 and 30 degrees using the + and – buttons, and the fan speed can be changed using the SPEED button. We advise for continuous drainage to be set up in HEAT mode.</p> <p>FAN (AIR PURIFIER): The fan speed can be changed pressing the SPEED button. When used with the optional HEPA filter, the appliance will work as an effective air purifier.</p> <p>DRY (DEHUMIDIFY): Should be operated without the vent hose, but with continuous drainage to remove moisture from the air. The display will show dH while in dry mode. The fan speed is set to low and is not adjustable.</p> <p>AUTO: The unit will automatically change between modes, depending on the room temperature and desired temperature set.</p>
	Repeatedly press the SPEED button to cycle through the five fan speeds. Each time the SPEED button is pressed, the fan speed will be displayed. The fan speed can be changed between F1 (Low) to F5 (High). The LED indicators will also illuminate to show the fan speed as below: F1 –Low, F2 – Low and Mid, F3 – Mid, F4 – Mid and High, F5 – High.
	Press to enter sleep mode. The sleep indicator will be illumined and all other indicators will be turned off. In sleep mode, the appliance works at low fan speed. Press SLEEP again to exit sleep mode.
	Press and hold the SLEEP button while the unit is in standby to activate the WiFi connection mode.

The timer functions cannot be combined or repeated.

POWER ON TIMER

With the appliance in standby, press the TIMER button to set the power-on timer. Use the + and - buttons to adjust the duration of the timer (1 to 24 hours). The Timer indicator will turn on and the unit will start after the selected number of hours.

POWER OFF TIMER

With the appliance running with the desired settings, press the TIMER button to set the power-off timer. Use the + and - buttons to adjust the duration of the timer (1 to 24 hours). The timer indicator will illuminate and the unit will stop after selected number of hours.



Used to adjust temperature in HEAT/COOL/SMART COOL modes and to set the duration of the TIMER. The buttons are not used in FAN or DRY modes. Press both buttons together to change between displaying the temperature in Celsius and Fahrenheit.

Press this button to enable the swing function. The louvres will slowly move from side to side. If swing is pressed again the louvres will stop in their current position.

REMOTE CONTROL

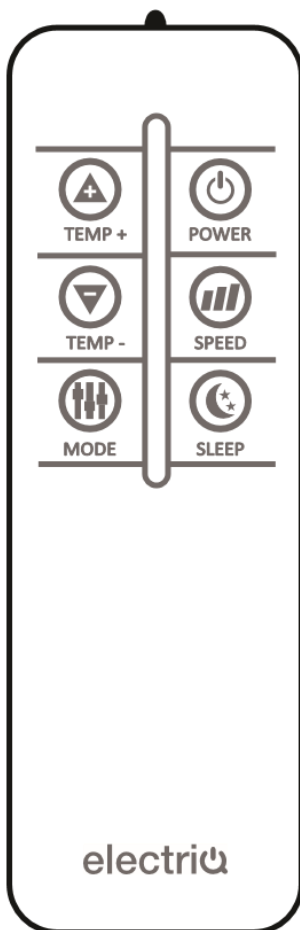

POWER	Press to turn the unit on or off.
TEMP -	Press to decrease the desired temperature or timer duration.
TEMP +	Press to increase the desired temperature or timer duration.
SLEEP	Press the sleep button to enter sleep mode.
SPEED	Press to change between the 5 fan speeds
MODE	Press to change between, Cool, Heat, Fan and Auto modes

NOTE: The design of the remote may vary from the diagram, due to continuous product improvement.

MULTI PROTECTIVE FUNCTIONS

FROST PROTECTION

In COOL, DRY or AUTO modes, if the temperature of the exhaust is too low, the machine will automatically stop operating until the temperature has risen.

OVERFLOW PROTECTION

When the water in the internal water tank exceeds the warning level, the machine will stop operating and sound an alarm with the LCD display showing "E7". To resume operation empty the internal water tank. After the water is emptied, the machine will automatically return to the original state.

AUTO-DEFROST

The machine has automatic defrosting function. If during operation the temperature of the internal coils drops too low, the unit will enter auto defrost and the heating symbol will flash on the control panel.

AUTOMATIC THERMAL PROTECTION

To protect the service life of the machine, the machine has automatic thermal protection. If the temperature within the unit is outside of the specified range, the compressor and the lower motor will stop operation. The appliance will automatically return to normal operation after the temperature of the machine recovers.

COMPRESSOR PROTECTION

To prevent damage to the compressor there is a 3 minute delay start protection function.

EMPTYING THE INTERNAL WATER TANK

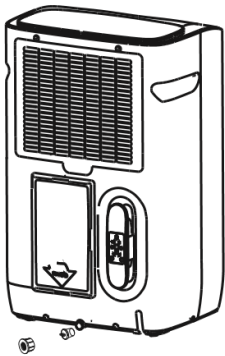

MANUAL DRAINAGE:

When the internal water tank is full the unit will stop working.

Shut off the unit and unplug. Try not to move the model abruptly as this may cause the water in the internal tank to spill out.

Place a tray under the lower water plug or place the unit in a drainage area.

Unscrew the drain plug cap and remove the rubber stopper - water will drain from the internal tank. Put the rubber stopper back and screw the drain plug cap back into place.

CONTINUOUS DRAINAGE:

Unscrew the drain plug cap and remove the rubber stopper.

Connect a water pipe to the water outlet. You can plumb this pipe into your current plumbing system, lead it outside and use gravity fall or use a water pump.

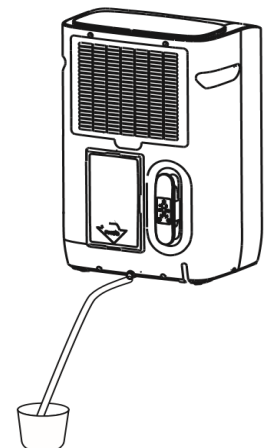

NOTE: This model has a self-evaporative function, which reduces the need to empty the water tank. If the unit is vented correctly most of the water is reused to cool the condenser coils and any excess is evaporated. Please do not use continuous drainage if you intend to use the self-evaporating facility.

WIFI SMART CONTROL

BEFORE YOU START

- Ensure your router provides a standard 2.4ghz connection.
- If your router is dual band ensure that both networks have different network names (SSID). The provider of your router / Internet service provider will be able to provide advice specific to your router.
- Place the air conditioner as close as possible to the router during setup.
- Once the app has been installed on your phone, turn off the data connection, and ensure your phone is connected to your router via WIFI.

DOWNLOAD THE APP TO YOUR PHONE

Download the "TUYA SMART" app, from your chosen app store, using the QR codes below, or by searching for the app in your chosen store.



Android



IOS

CONNECTION METHODS AVAILABLE FOR SETUP

The air conditioner has two different setup modes, Quick Connection and AP (Access Point). The quick connection is a quick and simple way to set the unit up. The AP connection uses a direct local WiFi connection between your phone and the air conditioner to upload the network details.

Before starting the setup, with the air conditioner plugged in, but turned off, press and hold the SLEEP button for 3 seconds (until you hear a bleep) to enter the WIFI connection mode.

Please ensure your device is in the correct WIFI connection mode for the connection type you are attempting, the flashing of the WIFI light on your air conditioner will indicate this.

Connection Type	Frequency of Flashes
Quick Connection (EZ Mode)	Flashes twice per second
AP (Access Point)	Flashes once per second

CHANGING BETWEEN CONNECTION TYPES

To change the unit between the two WiFi connection modes, hold the SLEEP button for 3 seconds.

REGISTER THE APP

1. Press on the register button at the bottom of the screen.

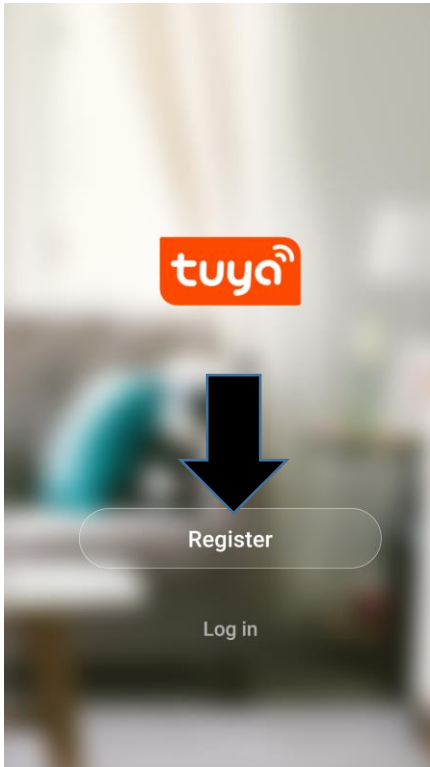

2. Read the Privacy policy and press the Agree Button.

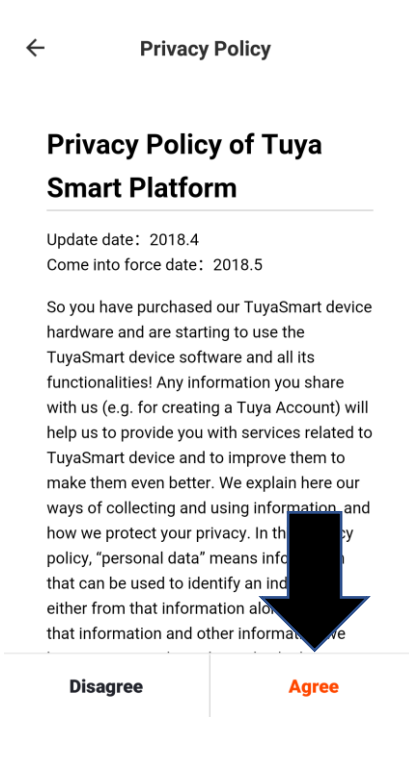

3. Enter your email address or phone number and press continue to register.

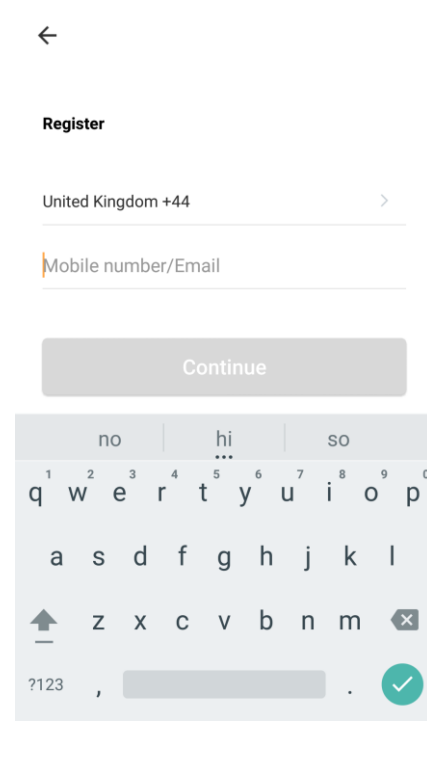

4. A verification code will be sent by the method selected in step 3. Enter the code into the app.

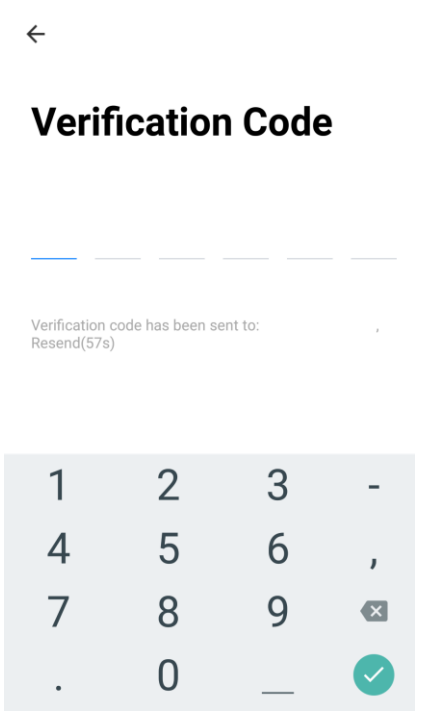

5. Type in the password you would like to create. This needs to be 6-20 characters, with letters and numbers.

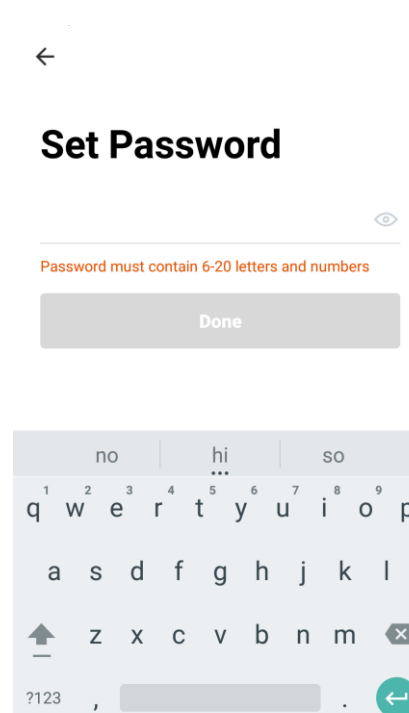

6. The app is now registered. It will automatically log you in following registration.

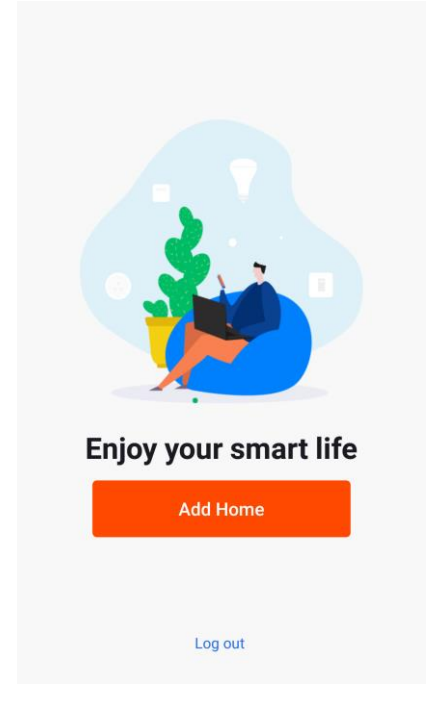

SETTING UP YOUR HOME WITHIN THE APP

TUYA is designed so it can work with a large number of compatible smart devices within your home. It can also be set up to work with multiple devices within different houses. As such during the setup process, the app requires that different areas are created and named to allow easy management of all your devices. When new devices are added, they are assigned to one of the rooms you have created.

CREATING ROOMS

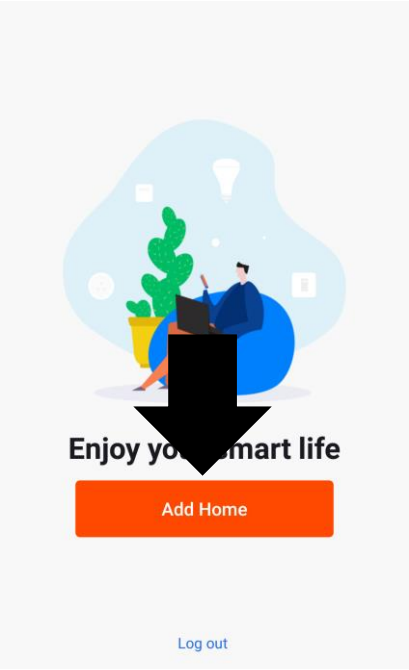
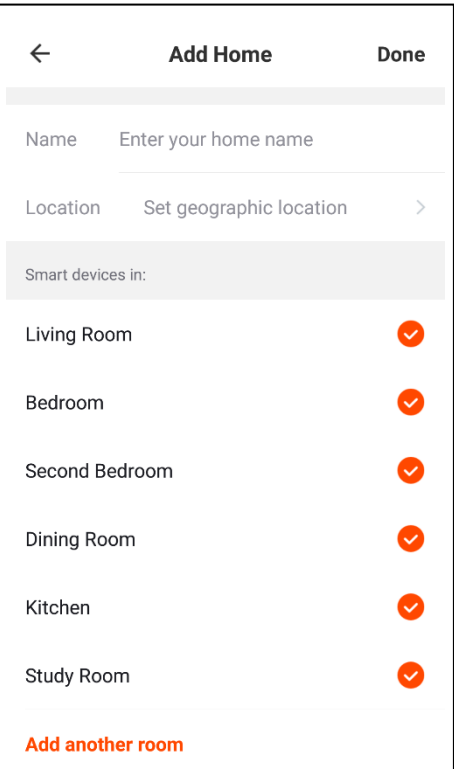
<p>1. Press on the ADD HOME button.</p> 	<p>2. Type in a name for your home, 3. Press on the location button to select the location of your home. (See SETTING YOUR LOCATION below) 4. New rooms can be added by pressing the ADD ANOTHER ROOM option at the bottom. (See ADD ANOTHER ROOM below) 5. Untick any rooms that are not required on the app. 6. Press DONE in the top right corner.</p>	
---	---	---

SETTING YOUR LOCATION

Use your finger to move the orange HOME symbol.

When the symbol is in the approximate location of your home, press the confirm button in the top right corner.

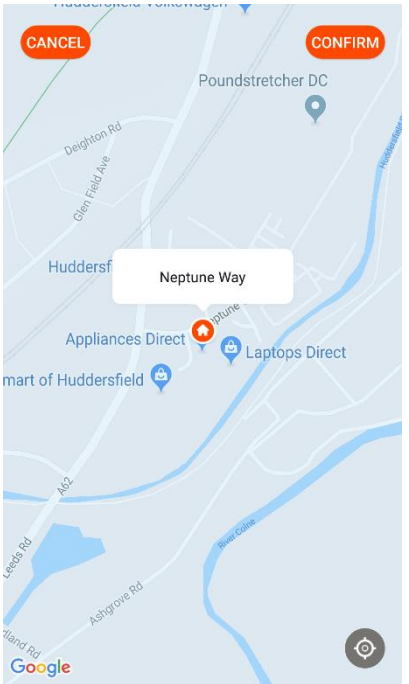

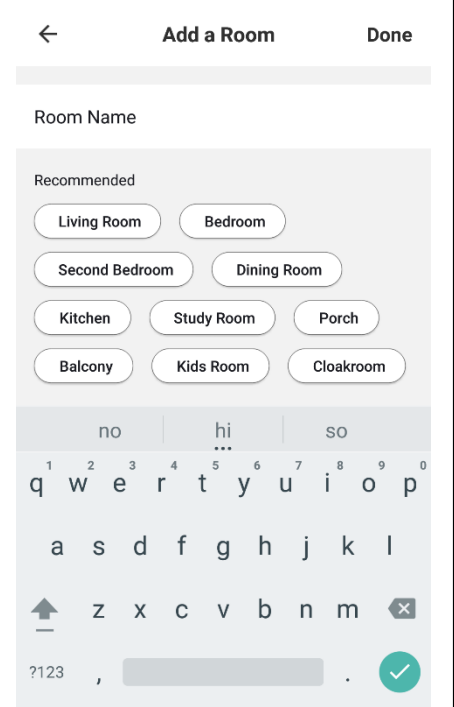

ADD ANOTHER ROOM

Type in the name of the room, and press Done in the top right corner

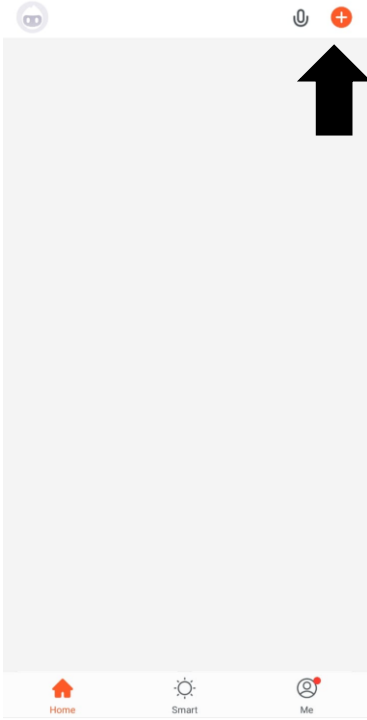

CONNECTING USING QUICK CONNECTION (EZ Mode)

Before initiating the connection, make sure the unit is in standby mode, with the WIFI light flashing twice per second. If not follow the instructions for changing the connection mode. Also ensure your phone is connected to the WIFI network. (We advise turning mobile data off during setup)

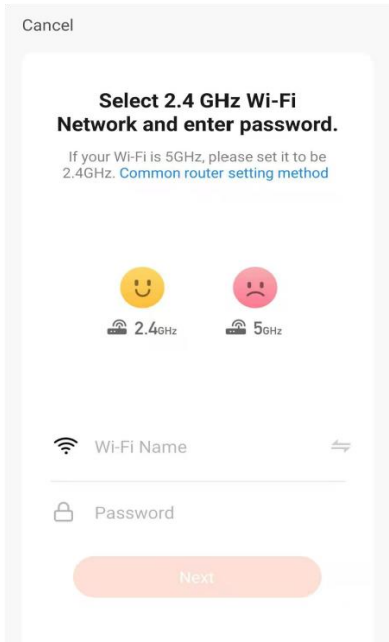
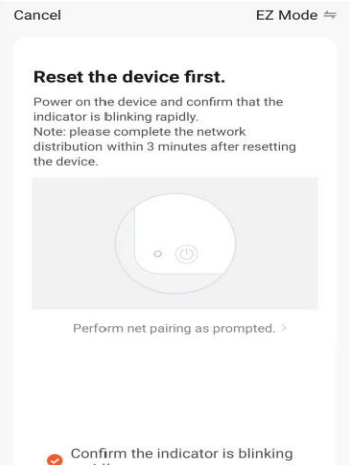
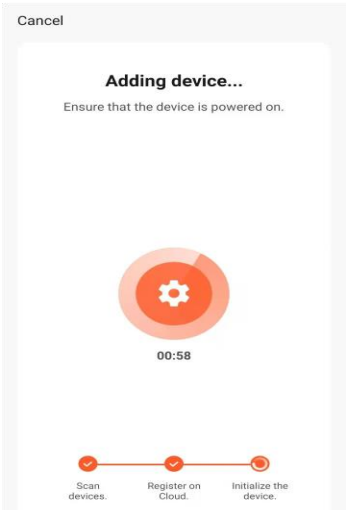
<p>1. Open the app and press “+” to add device</p> 	<p>2. Select the type of device as “Air Conditioner” within the Large Home Appliance tab.</p> 	<p>3. Select your network, enter your WIFI password and press Next.</p> 
<p>4. Ensure the WIFI light on the air conditioner is flashing twice per second then press on the orange button at the bottom of the screen to confirm</p> 	<p>5. This will then transfer the settings to the air conditioner. Wait for this to complete. If this fails, retry. If still unsuccessful please review the troubleshooting section for further help.</p> 	

CONNECTING USING AP MODE (ALTERNATIVE METHOD)

Before initiating the connection, make sure the unit is in standby mode, with the WIFI light flashing once per second. If not follow the instructions for changing the WIFI connection mode. Also ensure your phone is connected to the WIFI network. (We advise turning mobile data off during setup)

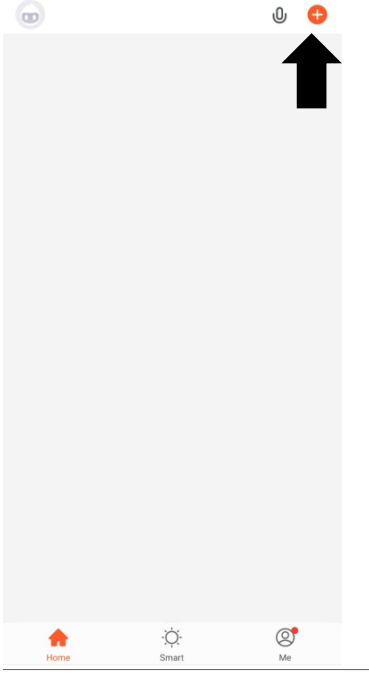
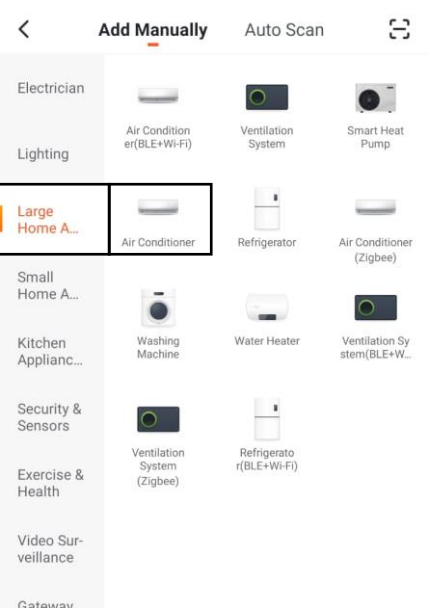
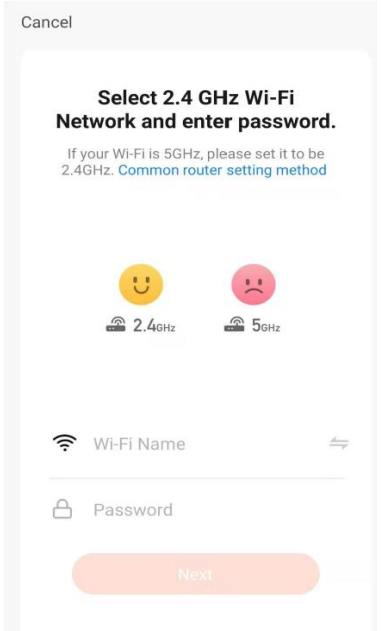
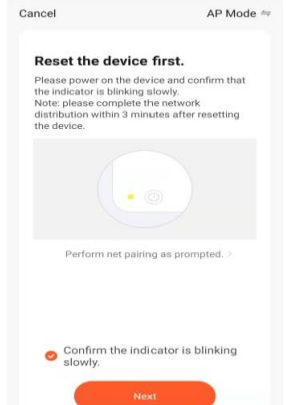
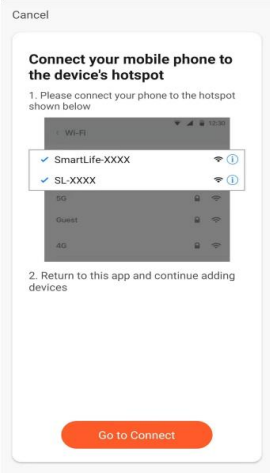
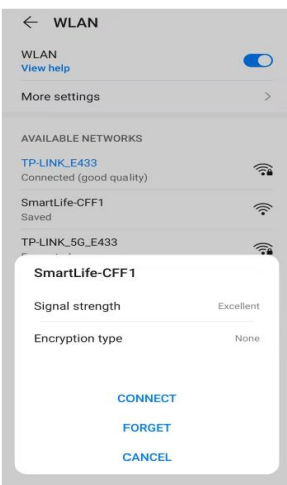
<p>2. Open the app and press “+” to add device</p> 	<p>2. Select the type of device as “Air Conditioner” within the Large Home Appliance tab.</p> 	<p>3. Select your network, enter your WIFI password and press Next.</p> 
<p>4. Ensure the WIFI light on the air conditioner is slowly flashing (once per three seconds), then select AP Mode in the top right corner before pressing on the orange button at the bottom of the screen to confirm</p> 	<p>5. Go to network settings in your phone and connect to the “SmartLife xxx” connection. then press on the orange button at the bottom of the screen to confirm</p> 	<p>6. Go to network settings in your phone and connect to the “SmartLife xxx” connection. There is no password to enter. Then return back to the app to complete setup.</p> 
<p>This will then transfer the settings to the air conditioner. Once the connection process has completed, go back to the network settings on your phone to ensure your phone has reconnected to your WIFI router.</p>		

CONTROLLING YOUR DEVICE THROUGH THE APP

THE HOME SCREEN

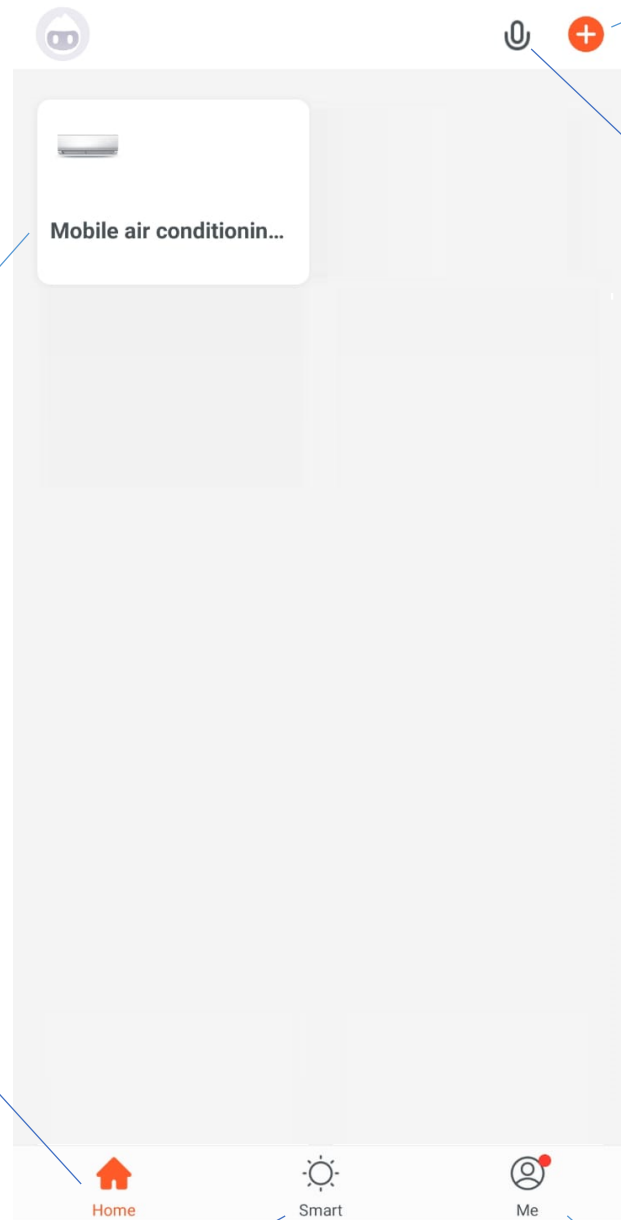

Add Device: Add a device to the app, and go through the setup process.

Your Device: Press to enter the device screen.

Voice Control: Use to give verbal instructions to the app.

Home: Return to this screen when within the Smart or profile tabs.

Smart Scene: Allows you to program intelligent behaviour based on the internal and external environment

Profile: Provides the option for changing settings, and adding devices using a QR code provided by a friend.

Each device has its own entry on the home screen to allow the user to either quickly turn the unit on or off, or to enter the device screen to make other changes.

DEVICE SCREEN

The device screen is the main control screen for the air conditioner, providing access to the controls to amend the functions and settings

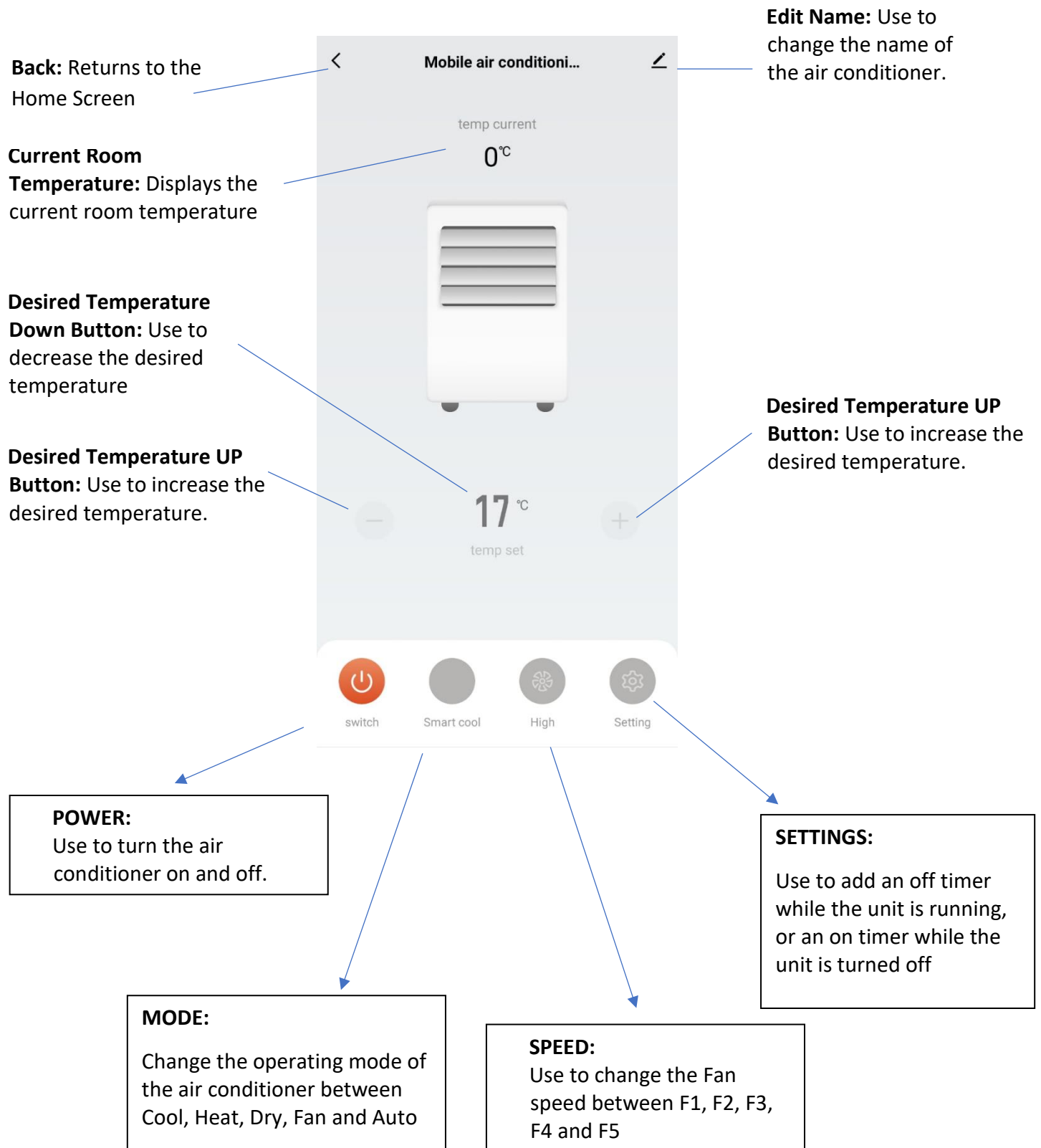

Due to continuous development of the app, the layout and available features may be subject to change.

CREATING ROOMS

The app is designed so that it can work with a wide variety of compatible smart devices within your home. It can also be set up to work with multiple devices in different locations. As such during the setup process the app requires that different areas are created to allow easy management of all your devices. When new devices are added they can be assigned to an existing room, or a new room created.

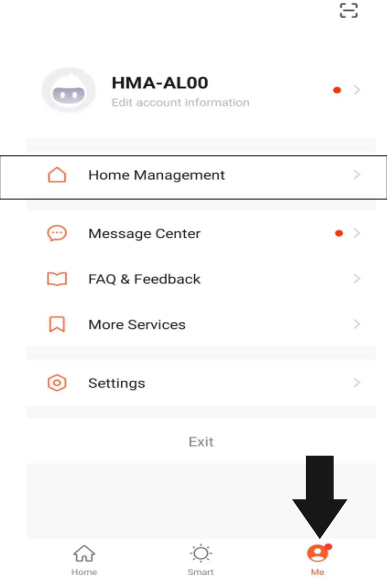
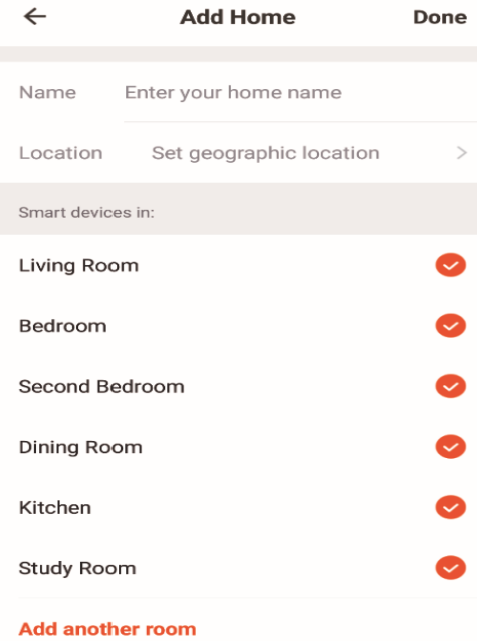
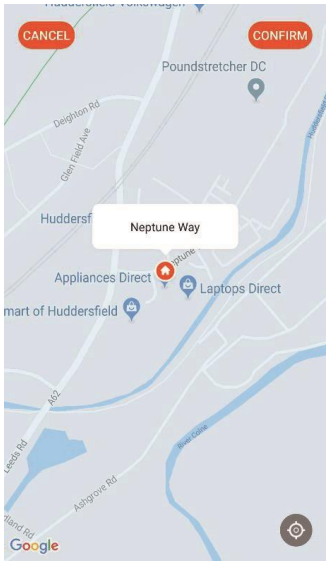
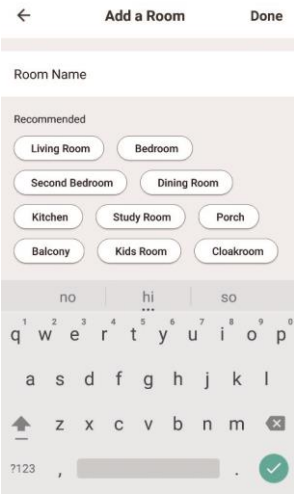
<p>1. ON THE HOME SCREEN Press on Home Management button</p> 	<p>2. Type in a name for your home, 3. Press on the location button to select the location of your home. (See SETTING YOUR LOCATION below) 4. New rooms can be added by pressing the ADD ANOTHER ROOM option at the bottom. (See ADD ANOTHER ROOM below) 5. Untick any rooms that are not required on the app. 6. Press DONE in the top right corner</p> 
<p>SETTING YOUR LOCATION</p> <p>Use your finger to move the orange HOME symbol.</p> <p>When the symbol is in the approximate location of your home, press the confirm button in the top right corner.</p> 	<p>ADD ANOTHER ROOM</p> <p>Type in the name of the room, and press Done in the top right corner</p> 



SMART SCENES

Smart Scenes is a powerful tool providing the option to customise the operation of the air conditioner based both on conditions within the room and outside influences. This gives the user the option of specifying much more intelligent actions. These are split into two categories Scene and Automation.

SCENE

Scene allows for a one touch button to be added to the Home screen. The button can be used to change a number of settings in one go, and can change all the settings within the unit. A number of scenes can easily be setup, allowing the user to easily change between a number of preset configurations.

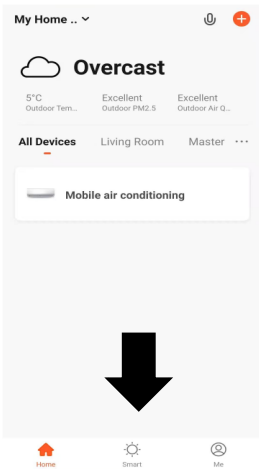
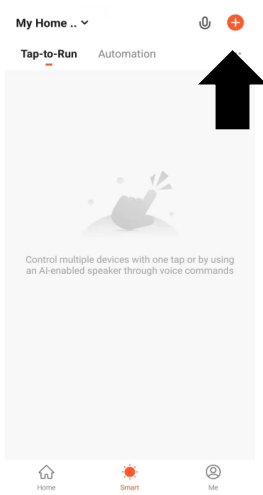
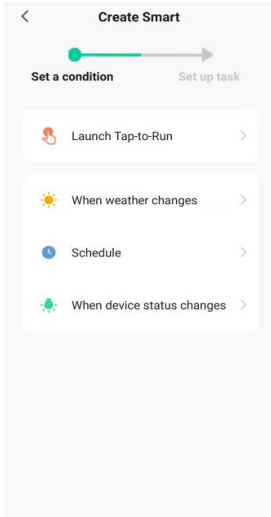
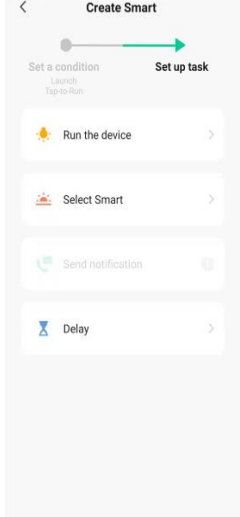
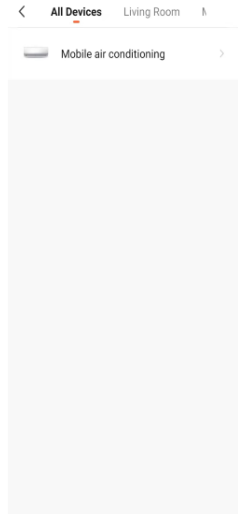
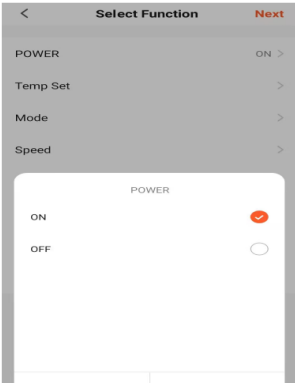
Below is an example of how to set up a scene:

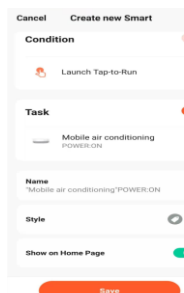
<p>1. Press on the Smart Scene tab at the bottom of the Home screen</p> 	<p>2. Press on the Plus in the top right corner to add a smart scene.</p> 	<p>3. Select the type of Scene to create.</p> 
	<p>4. Select Tap To Run, followed by the device you want to control.</p> 	<p>5. Choose the function, set the value for the function, and then press the back button in the top right corner, to return to the previous screen.</p> 
<p>6. Once all the functions required have been added, press the Next button in the top right corner to finalise and save your new Scene</p> 	<p>7. Once you have named your scene, save it, and the button will be available to activate the scene with one touch within the app.</p> 	

AUTOMATION

Automation allows an automatic action to be set up for the device. This can be triggered by the Time, indoor temperature, humidity of the room, weather conditions, and a range of other influences.

1. Press on the Smart Scene tab at the bottom of the Home screen

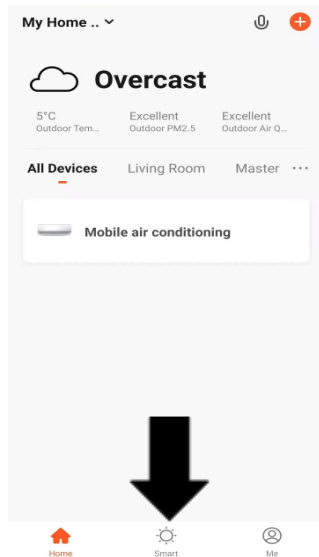

2. Press on the Plus in the top right corner to add a smart scene.

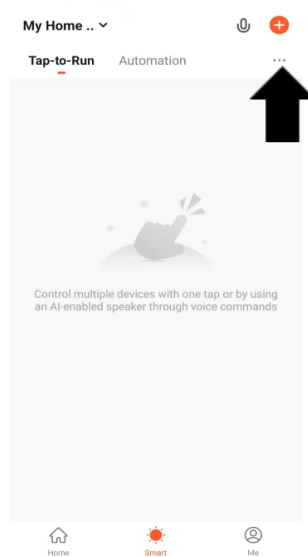

3. Select the type of automation required, such as on schedule for setting up a timed operation.

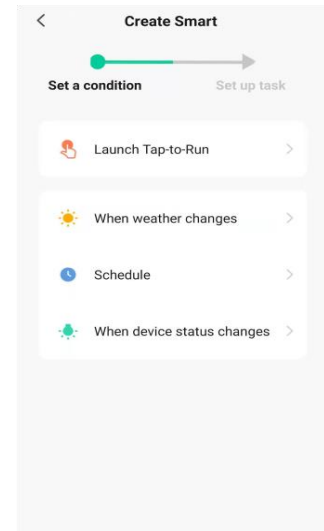

4. Select the condition when the automation should start. A number of triggers can be combined.

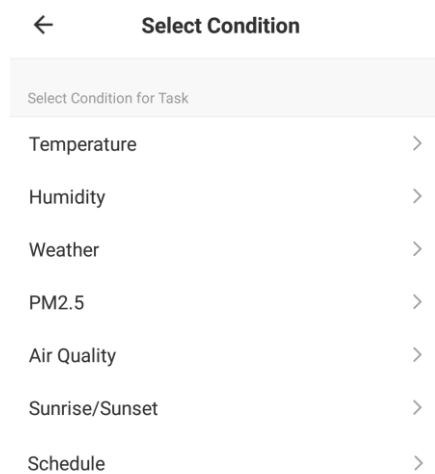

5. Chose the function, set the value for the function, and then press the back button in the top right corner, to return to the previous screen.

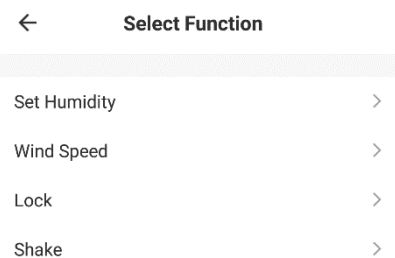

6. Once all the functions required have been added, press the Save button to finalise and save your automated action. The automation can be turned on and off as required.

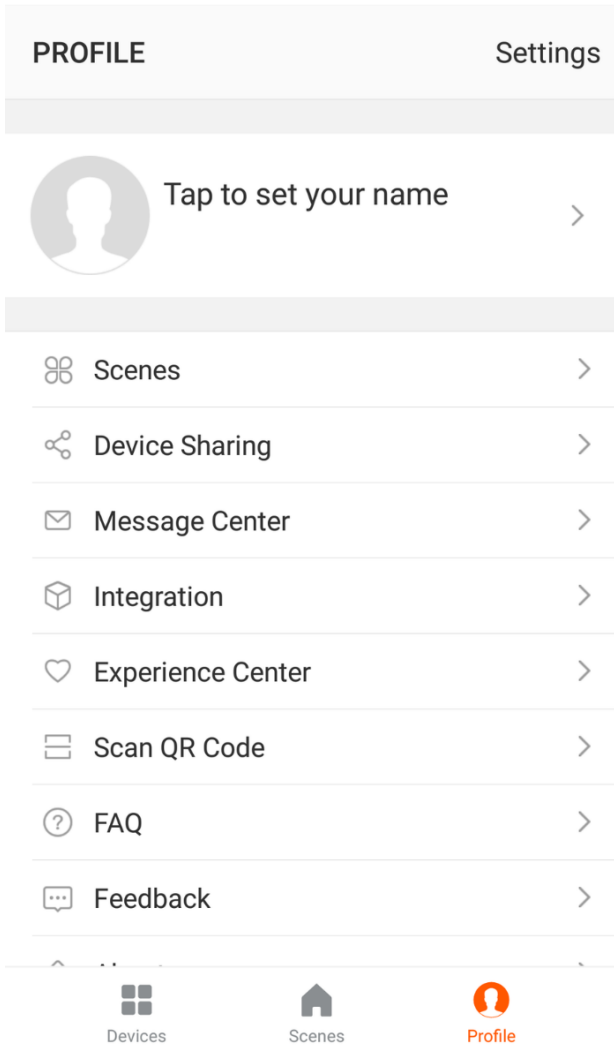

PROFILE TAB

The profile tab gives you the option to edit both your detail, and use the added features of the unit.

CHANGING THE NAME OF YOUR DEVICE

When in any of the device screens further settings for the device can be accessed, by pressing on the three dots in the top right hand corner. The top option within this allows you to change the name of the device to something relevant to the use of the product, such as “Living Room Air Conditioner”. Within the menu, you also have the option of setting up a pattern lock or change your password.

DEVICE SHARING

This allows you to share access to the controls of your air conditioner with friends and family.

INTEGRATION

This allows the unit to be integrated with your favourite home automation hardware such as Google Home and the Amazon Echo.

CONNECTION TROUBLESHOOTING

1. Check whether the device is powered on and is in the correct WiFi connection mode, if not please refer to the CHANGING BETWEEN CONNECTION MODES section on page 12.
2. Ensure the WiFi password has been entered into the app correctly (Case sensitive)
3. Check that the phone is connected to the WiFi you are connecting the device to.
4. Ensure the network you are connecting it to is 2.4Ghz (5Ghz WiFi networks are not supported), and that there is a strong WiFi signal to the item.
5. If your router is dual band, ensure that the 2.4ghz network has a different network name (SSID). Further advice on changing router settings will be available from your Internet service provider / Router manufacturer.
6. Check the settings on the router. Encryption should be WPA2-PSK and authorisation type should be set to AES
7. Try using the alternative connection method. i.e. If connection is failing when attempting to connect through CF mode, try AP mode.

MAINTENANCE AND CLEANING

PLEASE TURN OFF THE UNIT AND UNPLUG FROM THE MAINS BEFORE CLEANING OR PERFORMING ANY MAINTENANCE

CLEAN THE SURFACE

Clean the surface of the machine with a wet soft cloth. Do not use chemicals, such as benzene, alcohol, gasoline, etc; otherwise, as this may cause damage to the surface and or the internal workings of the machine

AIR FILTER CLEANING

If the filter screen is clogged with dust, the effectiveness of the air conditioner is reduced. The filter screen should be cleaned once every two weeks or as often as necessarily in your environment.

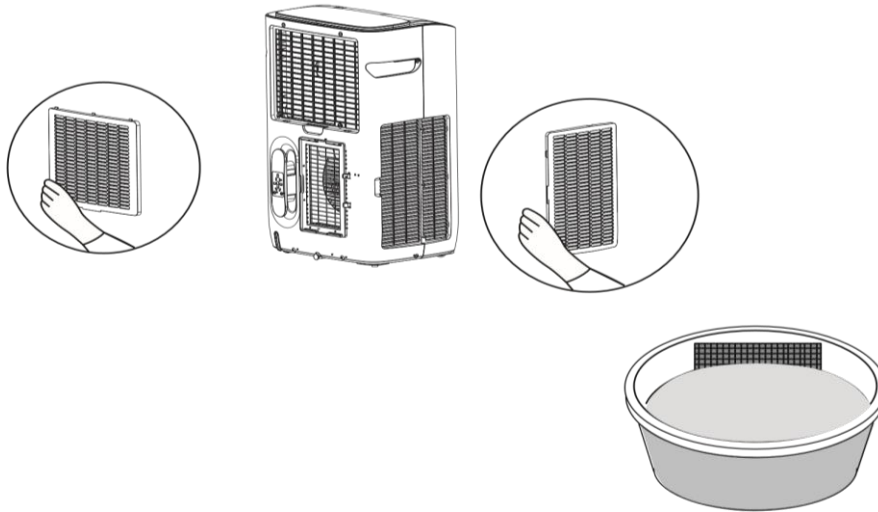

CLEAN THE UPPER FILTER SCREEN FRAME

Unclip the top of the evaporator filter screen from the appliance, and remove the HEPA filter (if installed). The HEPA filter should be regularly vacuumed and replaced when necessary (approx. every 6 months dependant on usage) The evaporator filter screen can be cleaned in warm water with neutral detergent (about 40°C /104°F). It must be rinsed clean and dried in the shade before reinstalling in the unit.

HEPA filters can be purchased from the stockist using the code: **FIL-ECOSILENTHEPA**.

CLEAN THE LOWER FILTER SCREEN FRAME

Hold the handle of the air inlet filter screen frame, and pull it outward gently to remove it. Put the filter screen into warm water with neutral detergent (about 40°C / 104 °F) °F). It must be rinsed clean and dried in the shade before reinstalling in the unit.

END OF SEASON MAINTENANCE

1. Remove the rubber stopper from the drainage hole and empty the internal tank. You can also drain the water by leaning the unit.
2. Then switch the unit to low fan mode.
3. Keep the unit in this mode for half day - until the conduit is dried. Doing this helps to keep the inside of the unit dry and prevents mould from developing
4. Turn off the unit and pull out the plug.
5. Replace the rubber stopper.
6. Coil the wire and bind it together, then put it into the accessories space.
7. Separate the air-exhaust pipe and store it safely.
8. Cover the unit and keep it in a dry place.
9. Take the batteries out of remote control and store or dispose of them safely. Keep all accessories with the unit ready for next season.

TROUBLESHOOTING

Do not repair or disassemble the air conditioning. Unqualified repair will invalidate the warranty and may lead to failure, causing injuries and property damage. Only use it as directed in this user manual and only perform operations advised here.

Problems	Reasons	Solutions
The air conditioner does not work.	There is no electricity.	Turn it on after connecting it to a socket with electricity.
	The display shows "E7".	Discharge the water inside.
	The ambient temperature is too low or too high	Only use to use the machine within temperature range of 7-35°C (44-95°F).
	In cooling mode, the room temperature is lower than the desired temperature	Change the desired temperature.
	In dry mode, the ambient temperature is low.	The ambient temperature must be above 17 °C. (62 °F).
The cooling effect is not good	There is direct sunlight.	Use curtains to reduce the direct sun heat
	Doors or windows are open; there are a lot of people; or in cooling mode, there are other sources of heat (e.g. fridges)	Close doors and windows; increase air conditioning power
	The filter screen is dirty.	Clean or replace the filter screen.
	The air inlet or outlet is blocked.	Clear obstructions; make sure venting is correct as described in this user manual and hose is not bent
Loud Noise	The air conditioning is not placed on a flat surface.	Put the air conditioning on a flat and hard place (to reduce noise).
Compressor does not work.	Overheat protection starts.	Wait for 3 minutes until the temperature is lowered, and then restart the machine.
The remote control does not work.	The distance between the machine and the remote control is too far.	Let the remote control get close to the air conditioner, and make sure that the remote control directly faces the receiver.
	The remote control is not aligned with the receiver.	
	Batteries are dead.	Replace batteries.
Others	No refrigerant or there is very little refrigerant	Refer to Service Centre (check leakage, welding, vacuum pump, charge refrigerant according to name plate)
	Anti-freezing protection	Waiting for defrosting. Function will recover automatically. No user input needed.
	High pressure protection	After inside gas pressure comes down, it will function normally. No user input needed

If problems not listed in the table occur or recommended solutions do not work, please contact the service centre.

ERROR CODES

CODE	CAUSE	SOLUTION
E2	Room temperature sensor error	Check to ensure filters are clean, vent pipe is not restricted, and room temperature is within operational range.
E3	Air Temperature sensor Error	
E7	Water Tank Full	Empty the water tank.
E5	Coil temperature sensor error	Check to ensure filters are clean, vent pipe is not restricted, and room temperature is within operational range.
MODE LIGHT FLASHING	Cool / dry / heating mode, the compressor has not started, the mode light will flash. This is normal	The unit will start operation when the protection period has finished (approx. 3 minutes)

APPENDIX



Disposal: Do not dispose this product as unsorted municipal waste. Collection of such waste must be handled separately as special treatment is necessary. Recycling facilities are now available for all customers at which you can deposit your old electrical products. Customers will be able to take any old electrical equipment to participating civic amenity sites run by their local councils. Please remember that this equipment will be further handled during the recycling process, so please be considerate when depositing your equipment. Please contact the local council for details of your local household waste recycling centres.

electriQ UK SUPPORT

www.electriQ.co.uk/support

Please, for your own convenience, make these simple checks before calling the service line. If the unit still fails to operate call the number below, or complete the online form.

0330 390 3061

1. Has the unit been standing upright for at least 2 hours?
2. Is the unit plugged into the mains?
3. Is the fuse OK?
4. Switch the unit off and wait three minutes to see if the issue is resolved. Restart the unit.
5. Check if the water tank is full.

Office hours: 9AM - 5PM Monday to Friday

www.electriQ.co.uk

Unit J6, Lowfields Business Park
Lowfields Way, Elland
West Yorkshire, HX5 9DA

DECLARATION OF CONFORMITY

Hereby, electriQ declares that this Portable air conditioner is in compliance with Directive 2014/53/EU. The full text of the EU declaration of conformity is available at the following internet address:

<https://www.electriQ.co.uk/content/declaration-of-conformity>

TECHNICAL DATA

Model		EcoSilent10HPW
Cooling capacity:	Cooling	10,000 BTU
	Heating	10,500 BTU
Input power:	Cooling	1100 W
	Heating	1150 W
Air flow volume:		350m ³ /h
Refrigerant:		R290/200g
Sound power level:		≤56dB(A)
Thermostat:		17-30°C
Maximum working pressure of suction/exhaust side:		1.0/3.5MPa
Maximum Allowable Pressure		3.5Mpa
Power Supply:		AC 220-240V/50Hz
Net Weight:		26kg
Dimension(L*D*H):		405 x 315x660mm
<p>Unit must be vented outside when in Air Cooling mode. For the purposes of EU regulation EN12102 this is a local air conditioner and produces less than 65dB(A) sound energy.</p> <div style="text-align: center;">  <p>R 290</p> </div>		